

Article number: 20240635450E

Description: E+G Telescope-Lear motion bearings GN 2406-35-450-E

Measures

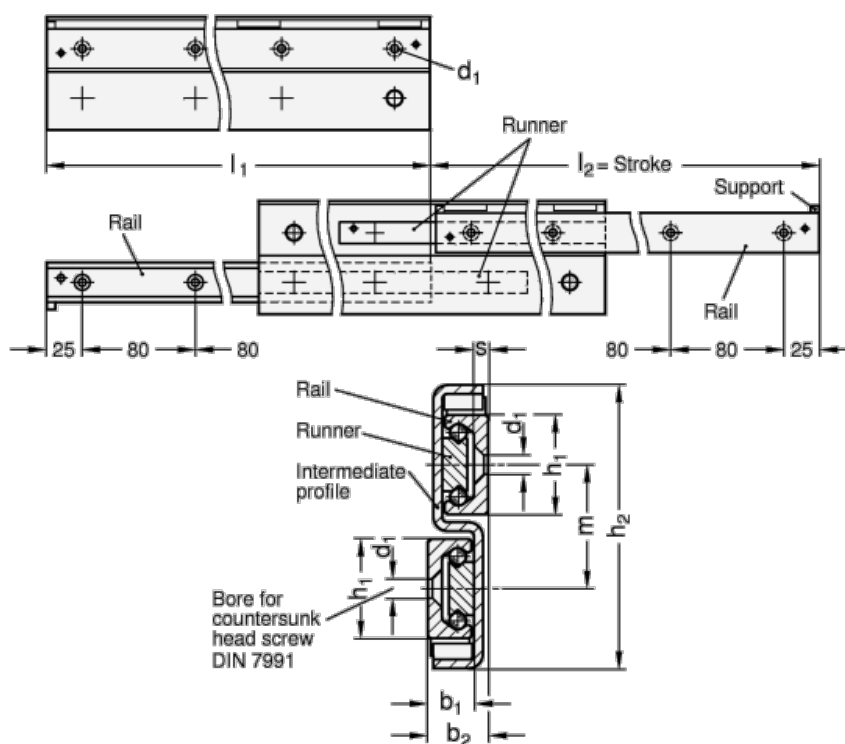

$b_1 = 16.5$

$b_2 = 22.5$

$d_1 = 6.5$

$h_1 = 35$

$h_2 = 97$

$L_1 = 450 - 494$

$m = 43$

$s = 3.5$

Weight in (g) = 4000